

IMEATEC

RELIABLE, BARRIER-FREE PROTECTION
AGAINST MOISTURE ON FACADES



DRAINAGE SYSTEM FOR TERRACES, ROOF GARDENS AND BALCONIES

COMPLETE DRAINAGE SYSTEM IN GALVANISED OR STAINLESS STEEL



Advantages

- > Drainage system in various heights, optionally with height-adjustable elevation devices
- > Can be cut to length individually
- > Asymmetrically positioned holes for the leveling feet in order to adapt to any installation situation (e.g. standard dimensions of window reveals)
- > Beveled edge for better connection to patio doors, despite wedge-shaped groove of the sealing strip at the base of the facade
- > Optimally matched components
- > Easy to install thanks to the MEATEC II 'insert and connect' system
- > Branch and drainage channels connected together optimally
- > Increased run-off rate
- > Integrated gravel borders
- > Aesthetically pleasing design
- > Cross bracing as a standard feature adds stability to the drainage channels making them resistant to side pressure

MEATEC II

CLEVER AND ELEGANT FACADE
DRAINAGE SOLUTION

MEATEC II SYSTEM OVERVIEW

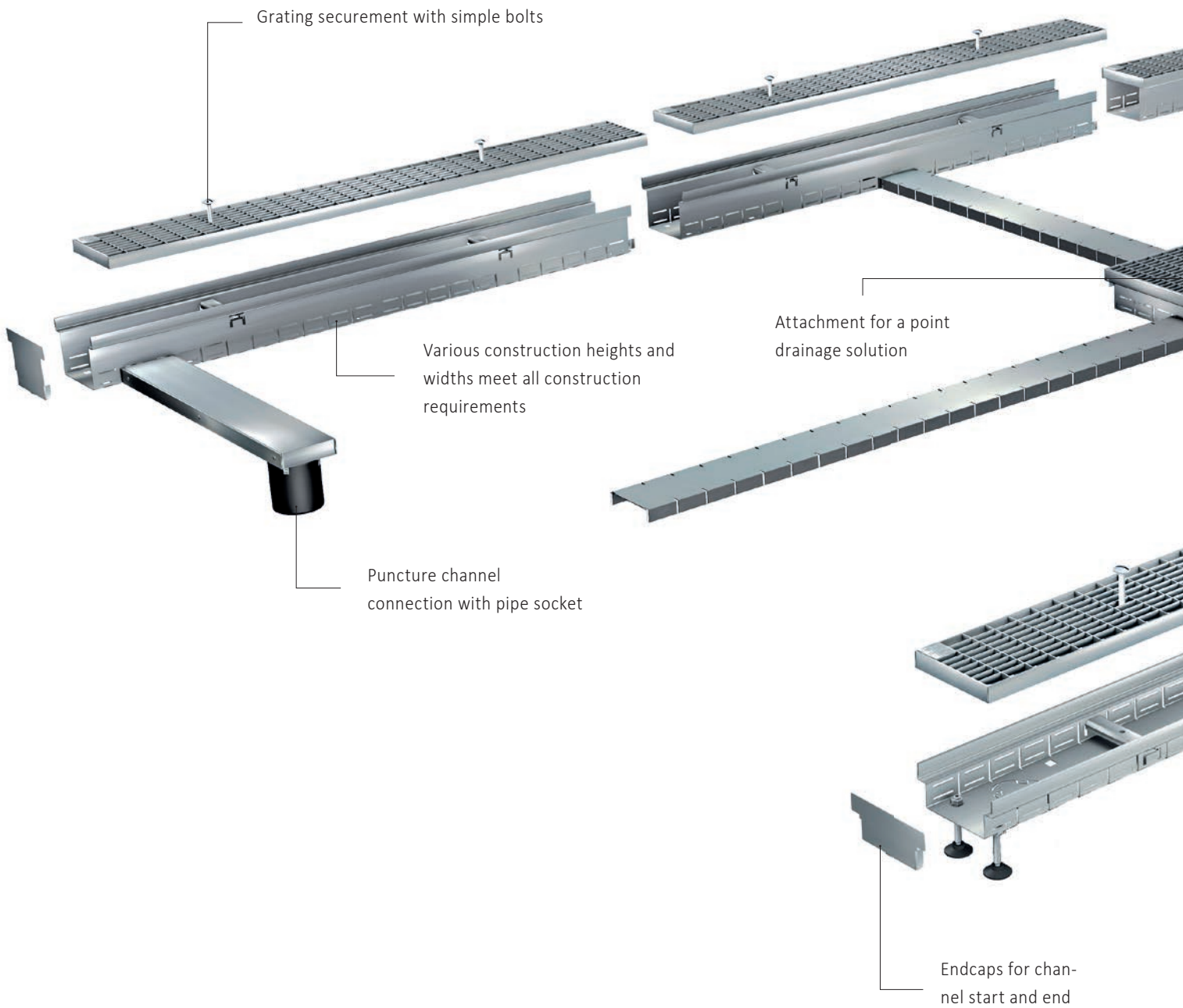

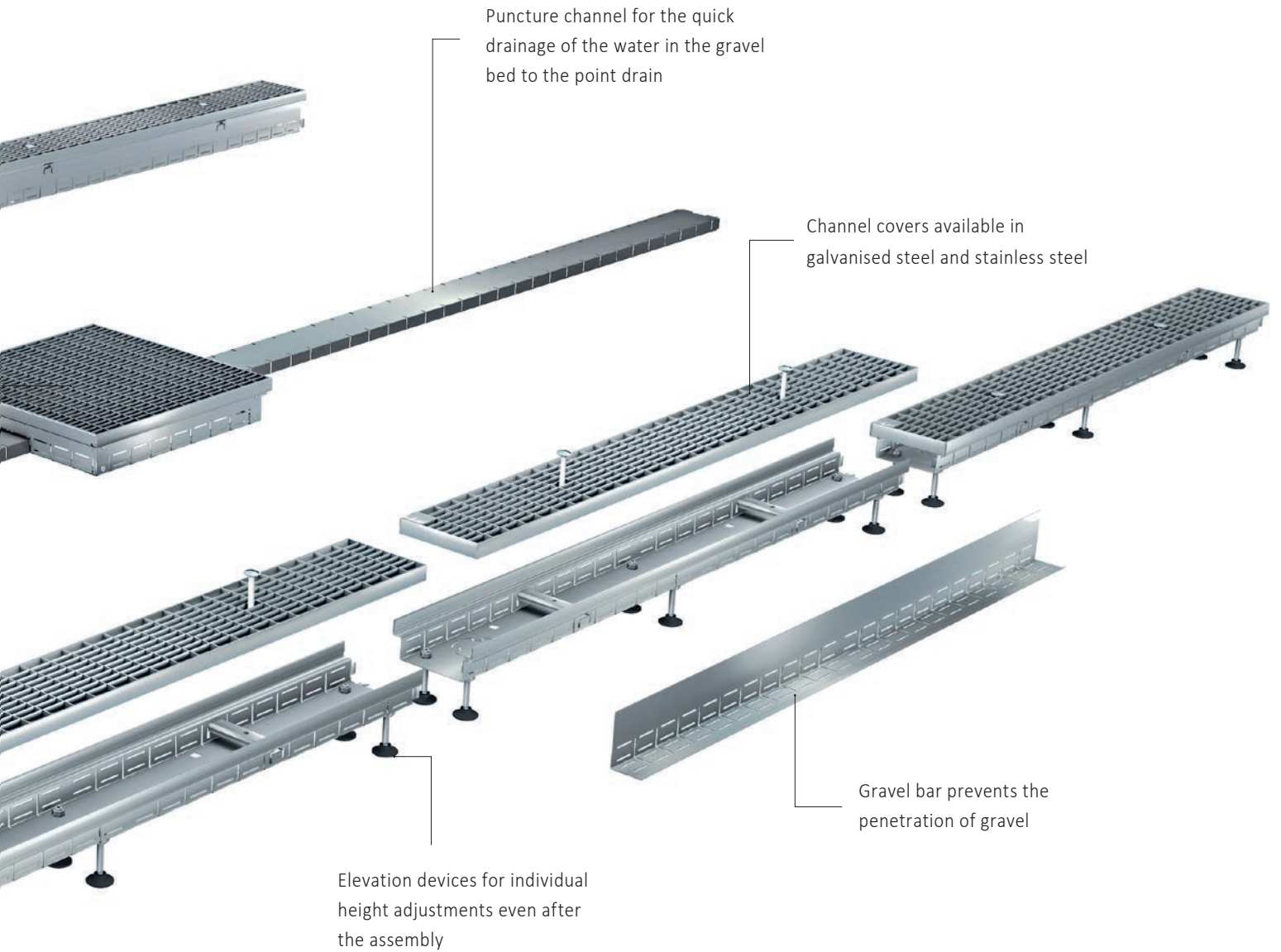

MEATEC II QUICK INSERTATION- PERFECT INSTALLATION

MEATEC – THE FASTER WAY TO ACHIEVE YOUR GOALS

The MEATEC ‘insert and connect’ system helps professional users install drainage channel elements quickly and easily.

- > ‘Insert and connect’ system simplifies installation: your drainage channel elements create a perfect visual impression
- > 2 m channel lengths allow rapid installation of the drainage channel system
- > Cross bracing as a standard feature adds stability to the drainage channels making them resistant to side pressure

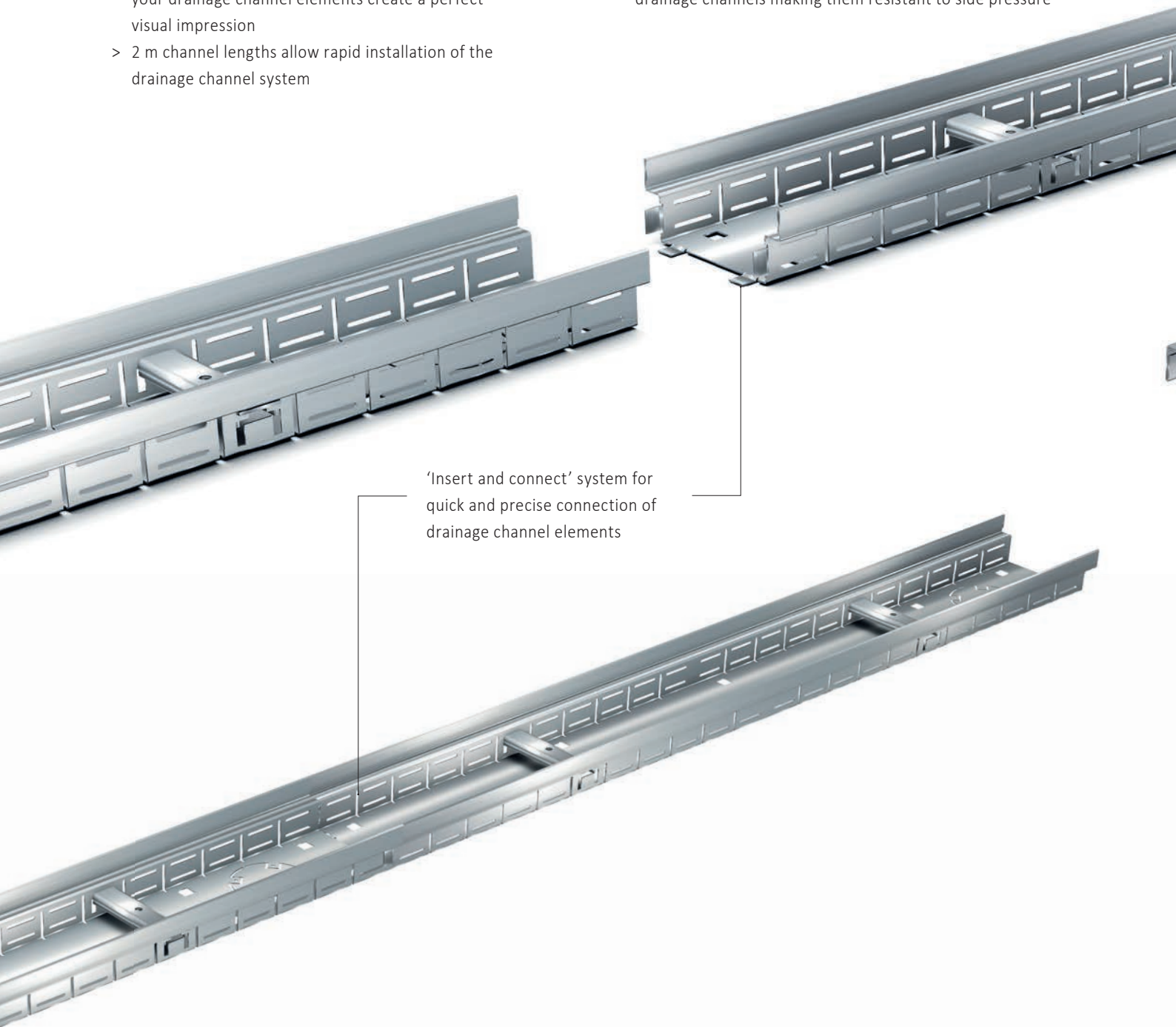

‘Insert and connect’ system for quick and precise connection of drainage channel elements

> Cross bracing as a standard feature adds stability to the drainage channels making them resistant to side pressure

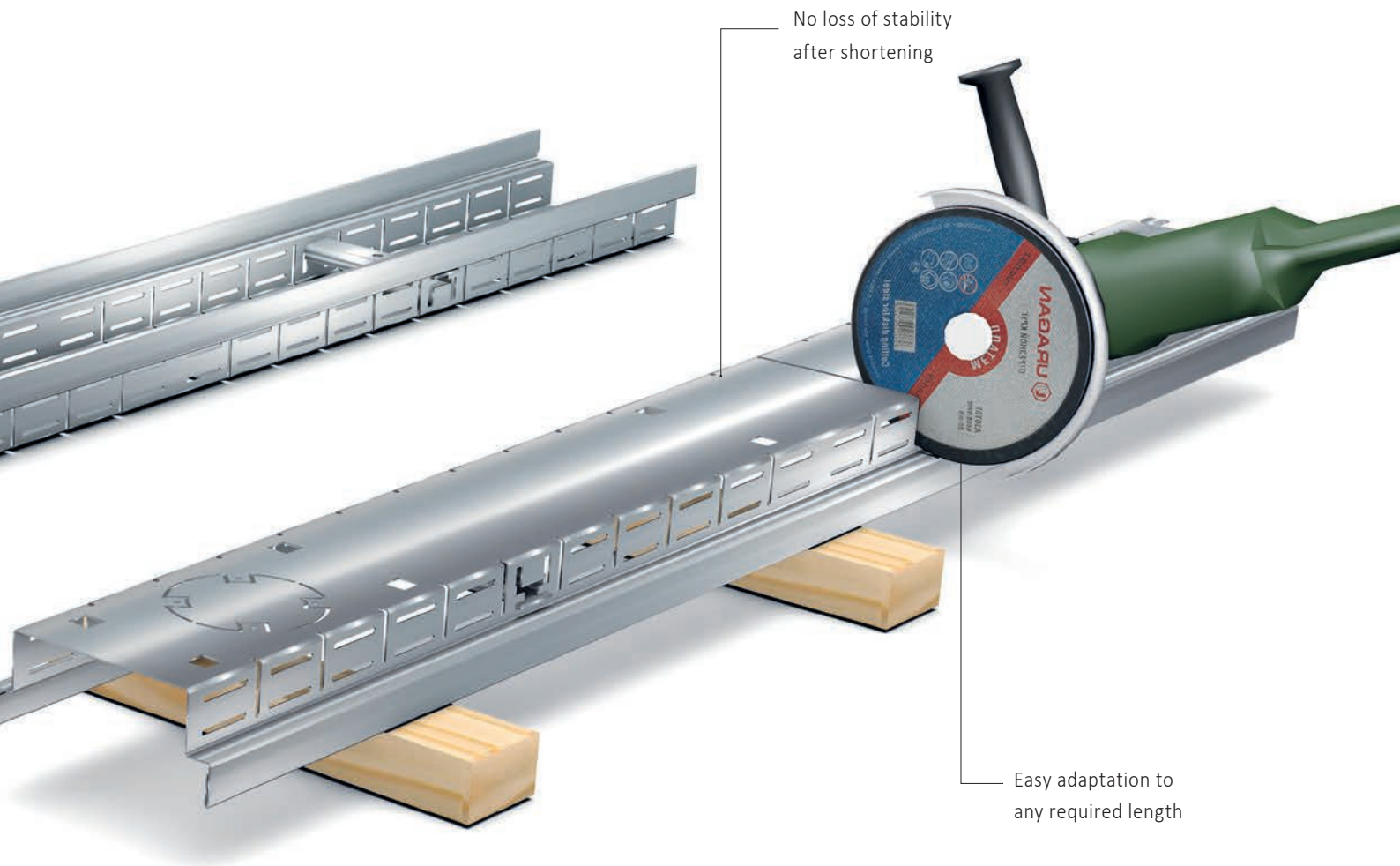

EASY TO SHORTEN WITH NO LOSS OF FUNCTIONALITY

- > Can be cut to length individually thanks to asymmetrical and selectable positioning of the adjustable feet
- > Can be cut to length without loss of function

MEATEC II CUT TO LENGTH AND HEIGHT ADJUSTMENT

CUTTING OPTIONS FOR ADAPTING THE MEATEC II TO STANDARD WINDOW WIDTHS

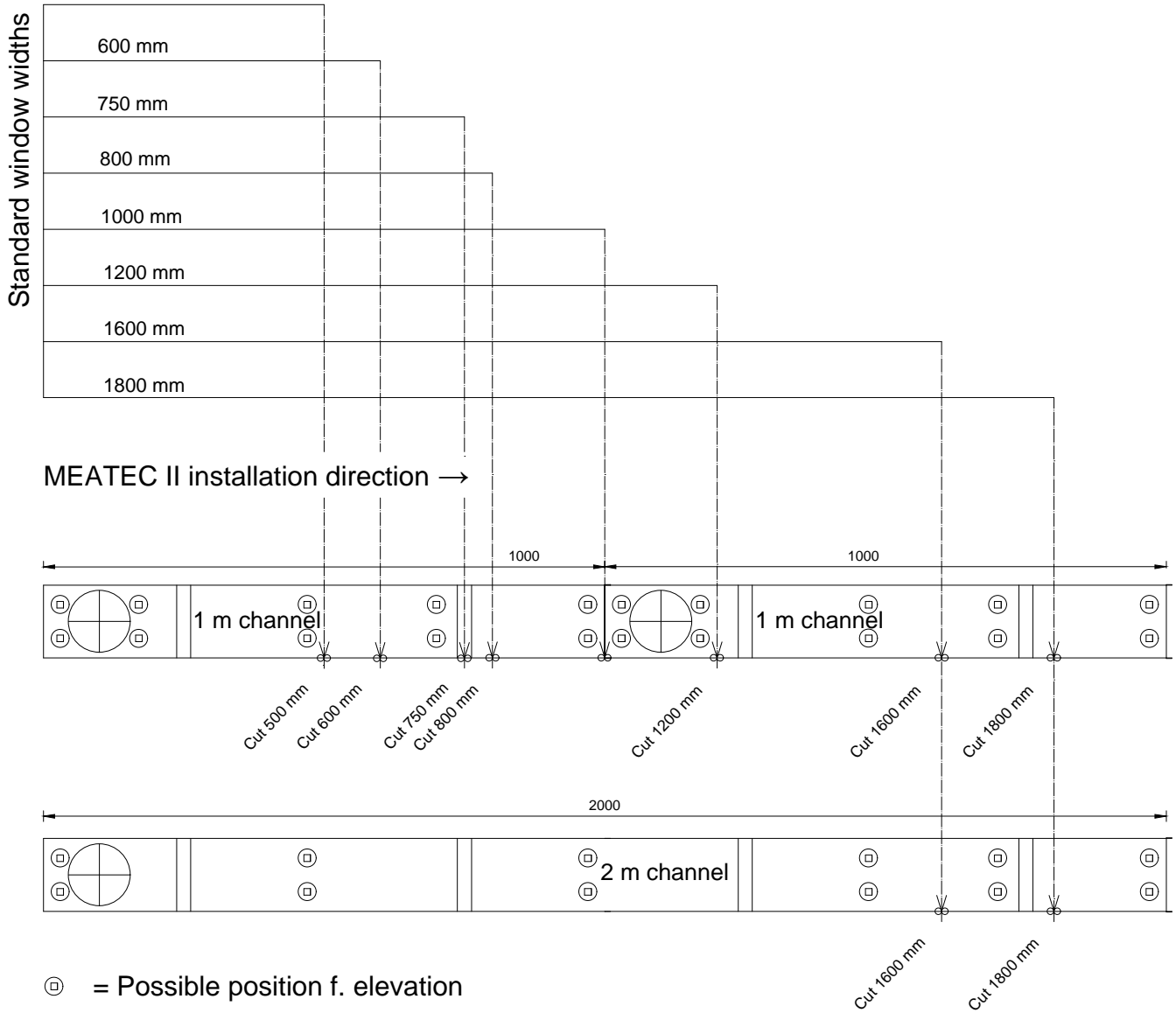

OVERVIEW FOR HEIGHT-ADJUSTABLE MEATEC II

Channel height 50 mm

Channel height 70 mm

Channel height 90 mm

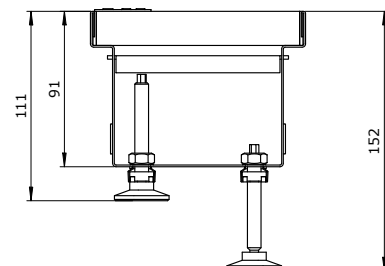
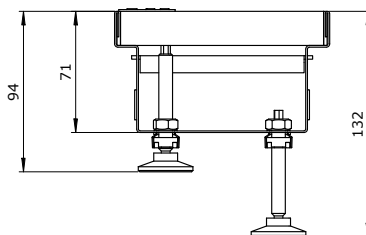
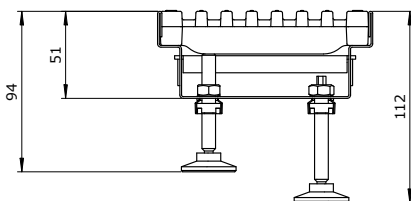

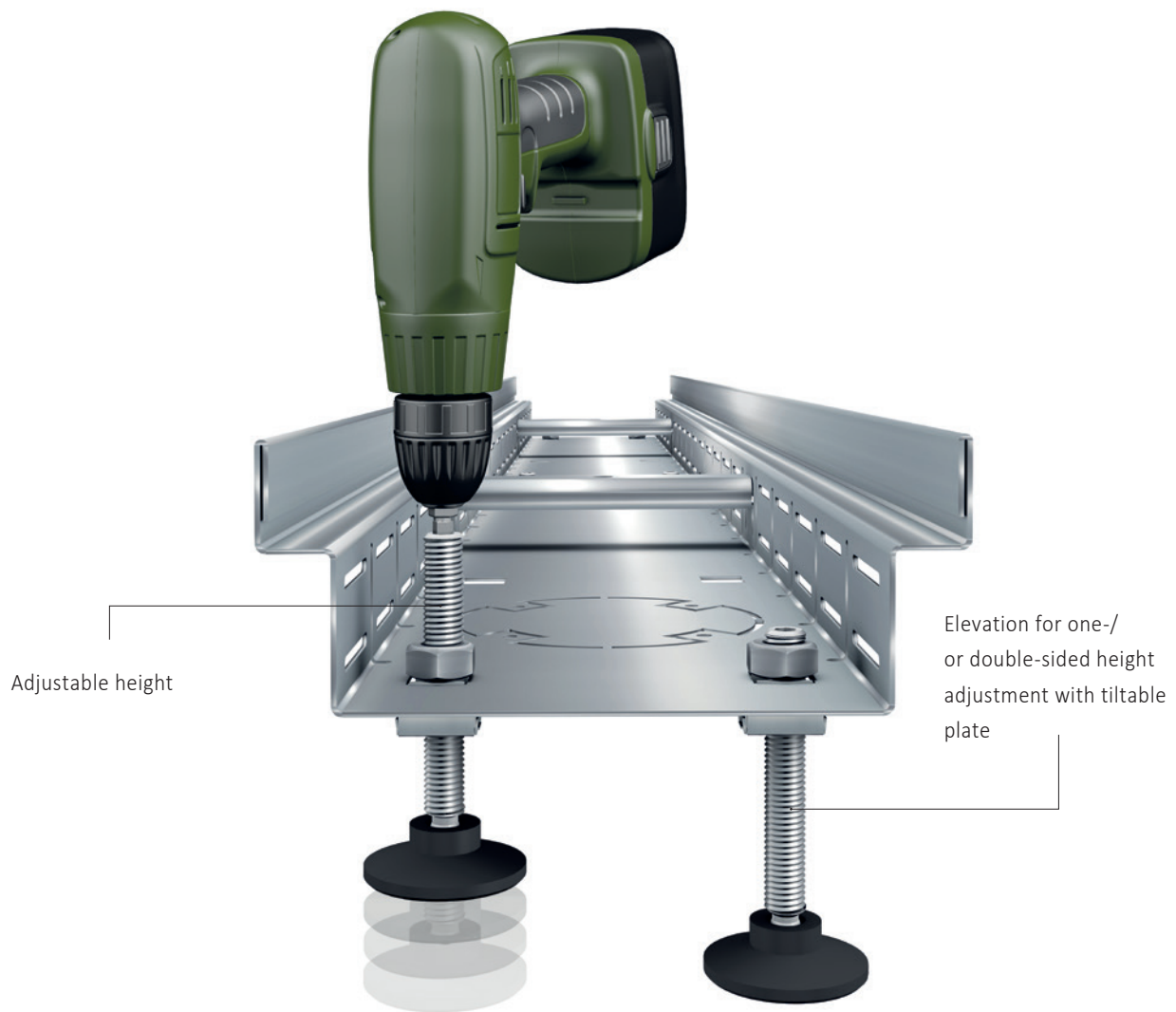

MEATEC II HEIGHT-ADJUSTABLE EVEN WHEN ALREADY INSTALLED

MEATEC II HEIGHT ADJUSTMENT

One big advantage of the MEATEC II system is that you can adjust the height:

- > With the fixed heights of 50, 70 and 90 mm and the individual height adjustment by means of adjustable feet, the MEATEC II system can cover all construction requirements
- > If the gravel bed subsides, you can adjust the height of the drainage channel accordingly without any problems, even though it is already installed
- > one-sided height adjustment of the trough (ramp-like) thanks to tiltable plates of the elevation for solving the constructional challenge for barrier-free building



MEATEC II BARRIER-FREE INSTALLATION

BARRIER-FREE INSTALLATION

The MEATEC drainage system enables barrier-free construction and provides permanent protection against moisture damage on a building's facade.

- > MEATEC system prevents moisture penetration in sensitive door and window areas in accordance with flat roof regulations as well as DIN 18531 and DIN 18040, Parts 1 and 2
- > Level access from living areas to rooftop terraces, balconies or loggias and step-free entrance areas – including to public buildings – are generally laid down today by planning regulations
- > Barrier-free accessibility for the disabled or elderly is a requirement for both new and refurbished buildings
- > Barrier-free access for wheelchairs, small children, shopping trolleys, etc. is also a tremendous help in everyday life

MEATEC II

IMPROVED VENTILATION OF FACADES

OPTIMAL REAR VENTILATION OF THE FACADE

- > Newly designed MEATEC system helps improve your façade's rear ventilation and protects it from moisture damage
- > Problem-free evaporation prevents waterlogged facades

MEATEC protects the building fabric permanently and puts a stop to expensive structural damage.

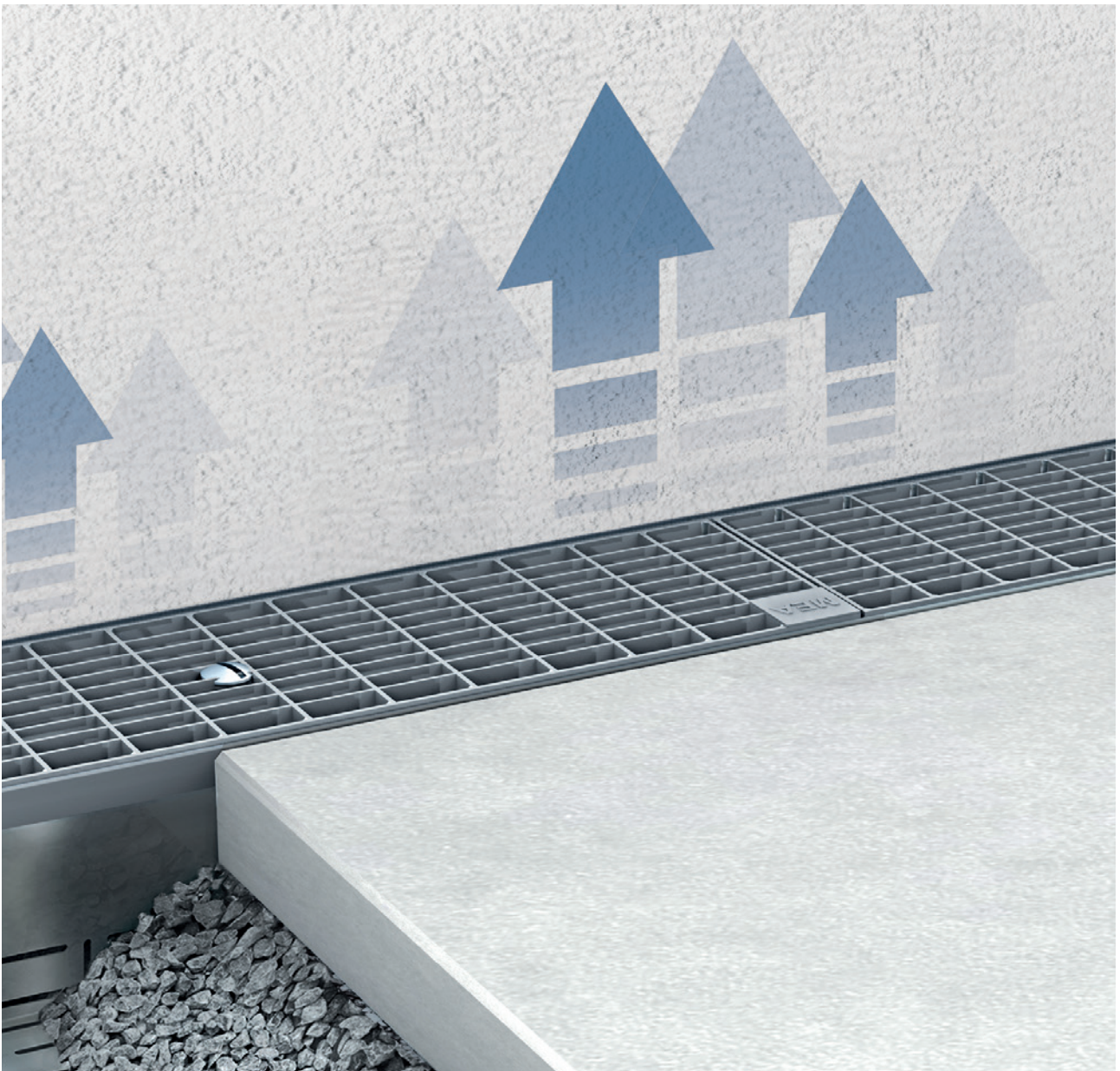

MEATEC II DRAINAGE THROUGH GRAVEL BED

SIMPLE AND EFFECTIVE DRAINAGE WITH MEATEC II

With this installation variant, the escaping water is drained from the lateral slots of the MEATEC II channel on the bituminous sheeting into the gravel bed.

- > The high number of lateral slots with intelligent slot geometry ensures fast drainage
- > The gravel bar on the elevated channel ensures protection against gravel penetration
- > In the case of an elevated channel in conjunction with the gravel bed a gravel bar is necessary

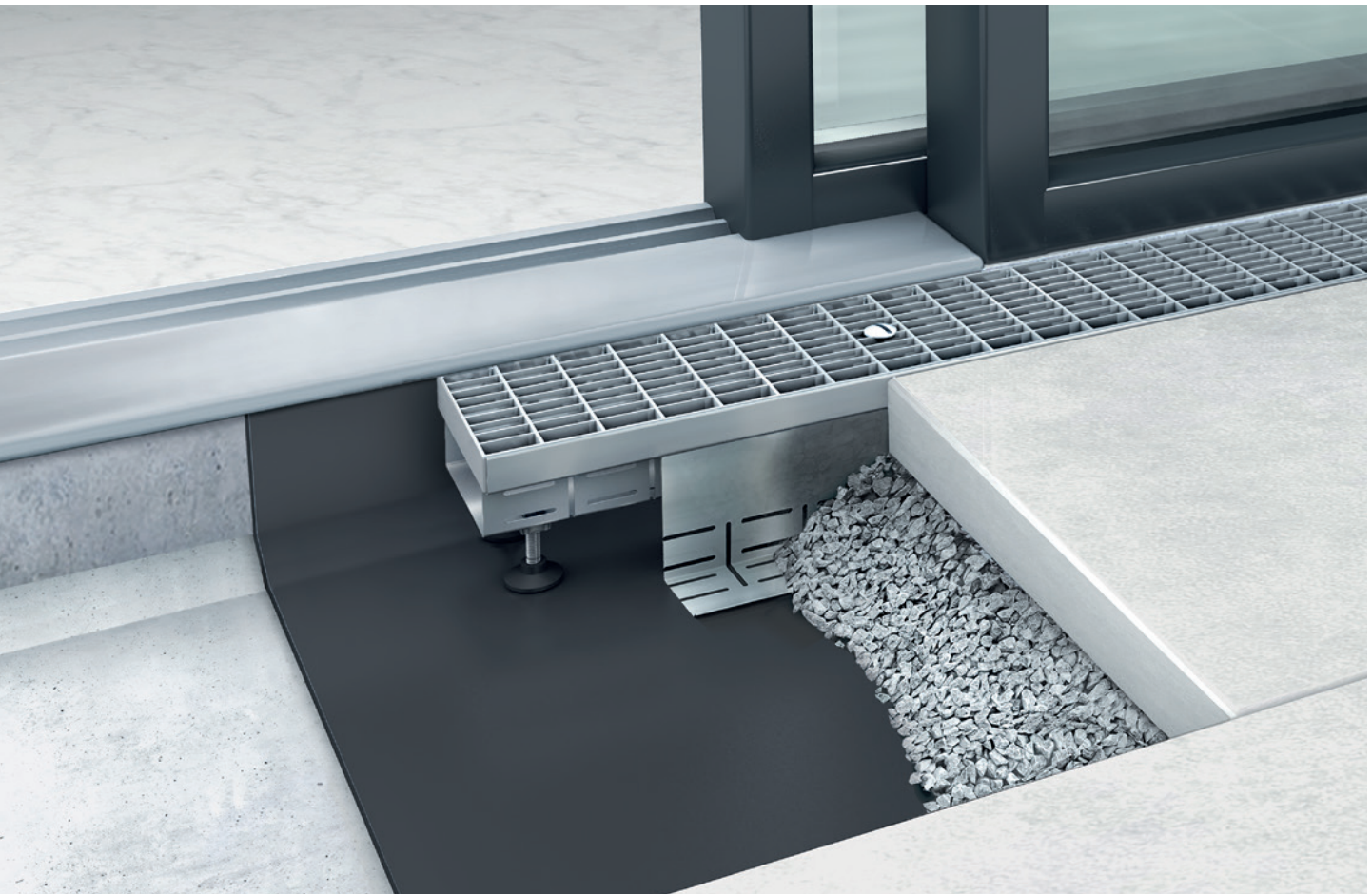

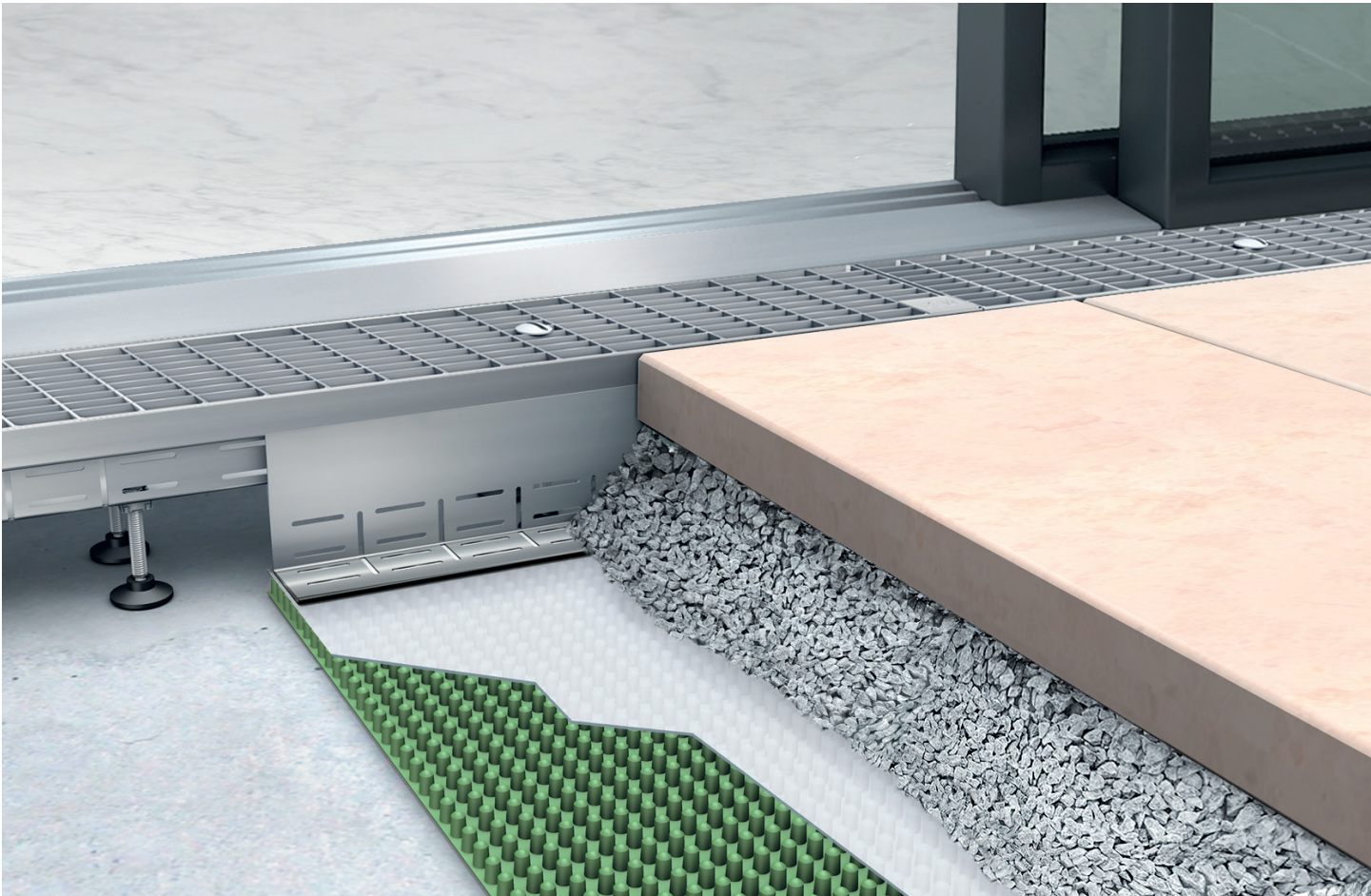

MEATEC II DRAINAGE USING A DRAINAGE MAT

DRAIN MOISTURE QUICKLY AND EFFECTIVELY WITH MEATEC II

- > With this installation variant, a drainage mat drains off the water under the pavement
- > Increased hydraulic performance
- > The felt separates the gravel layer from the drainage mat.
- > A gravel bar prevents the penetration of gravel

MEATEC II RAIN WATER DRAINAGE WITH ELEVATED FLOOR COVERING

DRY FASTER WITH MEATEC II

- > With this installation variant, the floor covering is laid on stilt bearings thus creating a hollow space. The surface water absorbed by the MEATEC II system can then drain away unhindered under the covering.
- > Due to the high number of lateral slots and the intelligent slot geometry, every calculated and required drainage performance can be achieved in accordance to DIN EN 12056-3 and DIN 1986-100.
- > The high number of lateral slots on both sides guarantees fast water drainage.

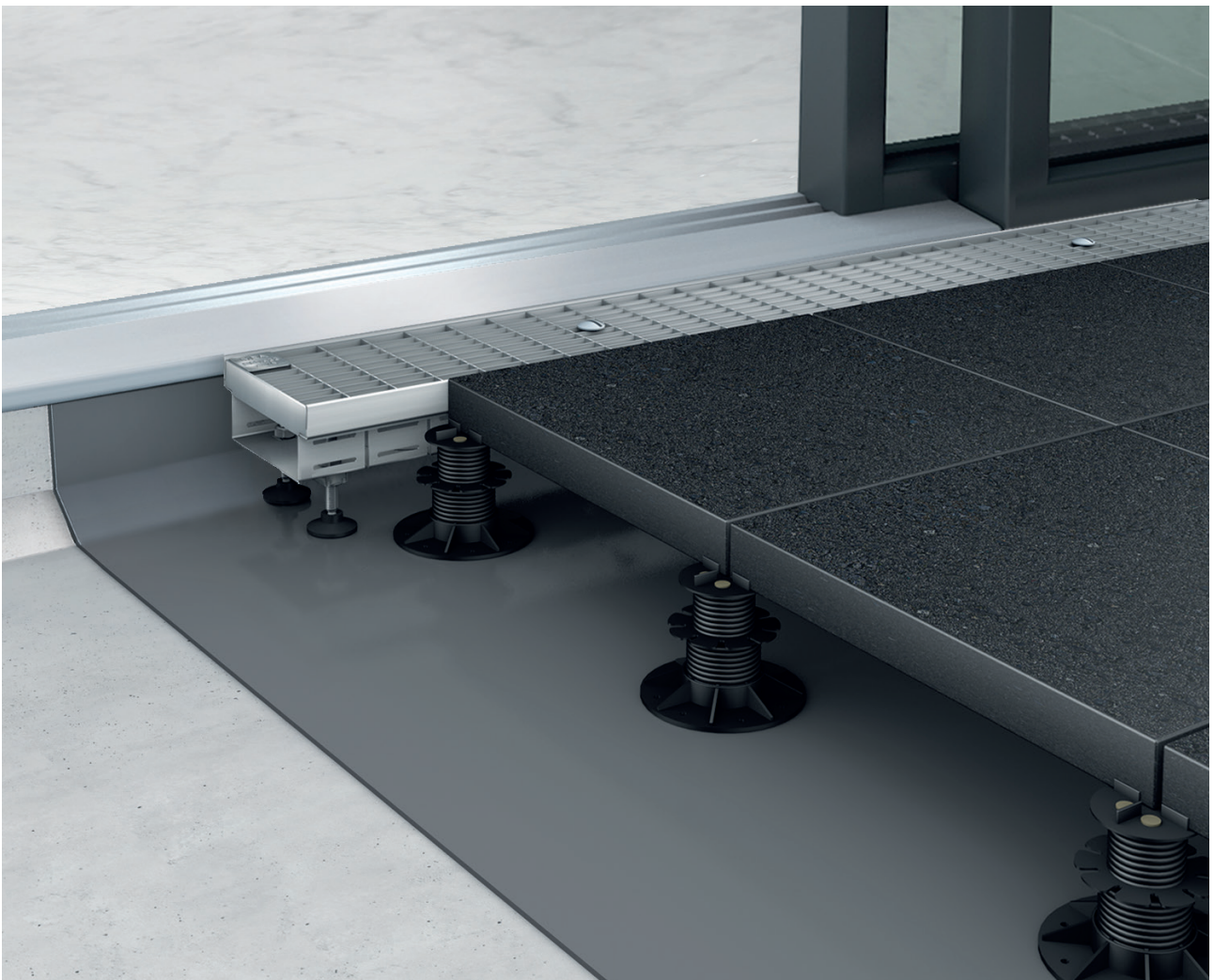

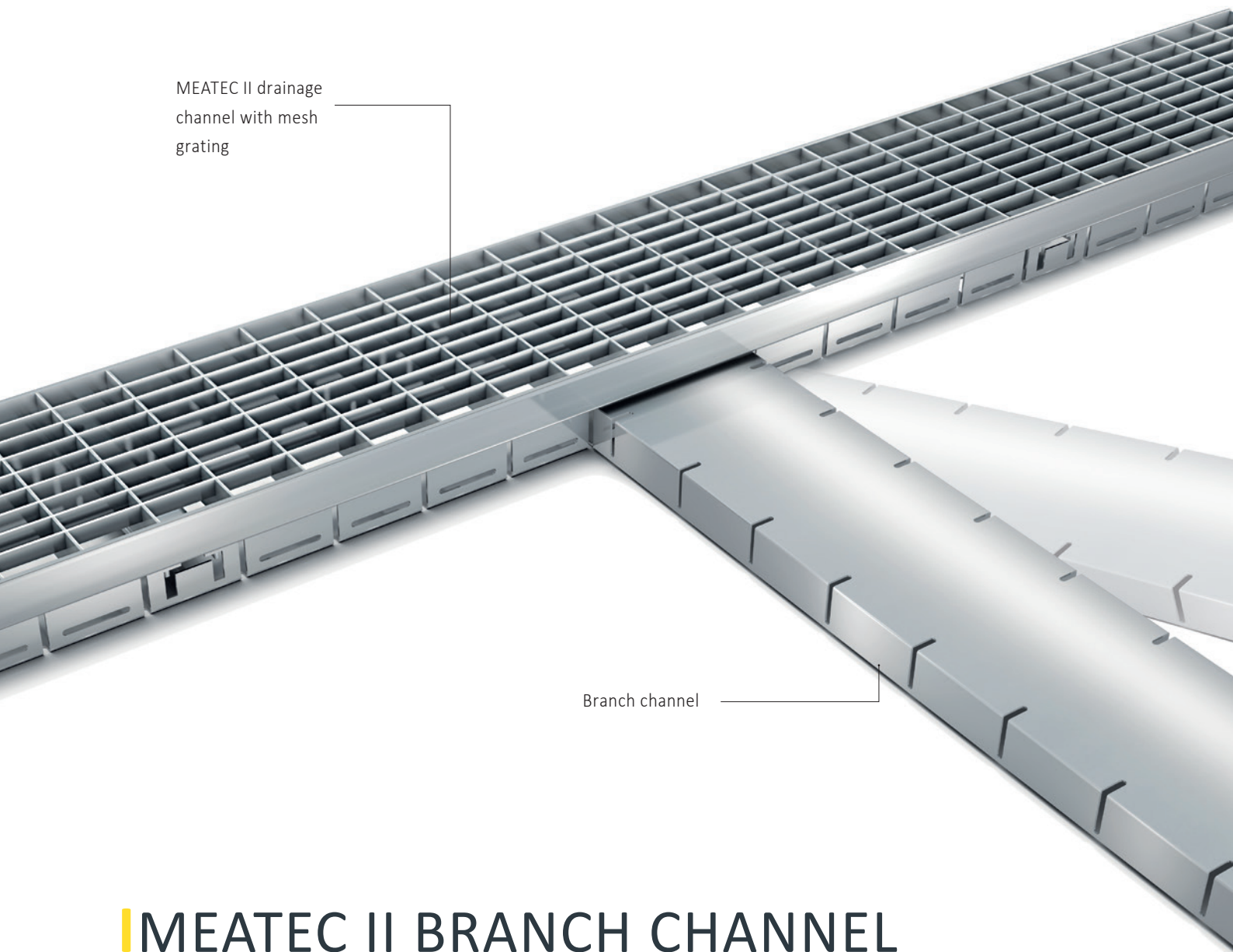

MEATEC II drainage
channel with mesh
grating

Branch channel

MEATEC II BRANCH CHANNEL

THE RIGHT CONNECTION

BRANCH CHANNEL OPTIMALLY CONNECTED

The branch channel connects the drainage channel elements to the emergency gully attachments and is a key system component. Any rainwater or melt water which collects is drained off reliably.

- > Branch channels installed underneath the paving slabs as drainage elements
- > Branch channel dimensions match the slot geometry on both sides of the drainage channel elements
- > Simply open the side of the drainage channel and insert the branch channel; it is then locked in position while you place the gravel bed
- > The branch channel can also be flexibly routed with a deviation of up to 15° to the point drain/emergency overflow.

MEATEC II DRAIN PREFORM FOR SIMPLE NOZZLE CONNECTION

PREFORMED DRAIN CONNECTOR

- > After the drain preform has been opened, the flaps are folded out. The nozzle is then screwed to them.

Nozzle diameter for following systems

- > MEATEC II 100 Ø 50 mm
- > MEATEC II 130 Ø 75 mm
- > MEATEC II 160 Ø 75 mm
- > MEATEC II 200 Ø 110 mm
- > MEATEC II 250 Ø 110 mm

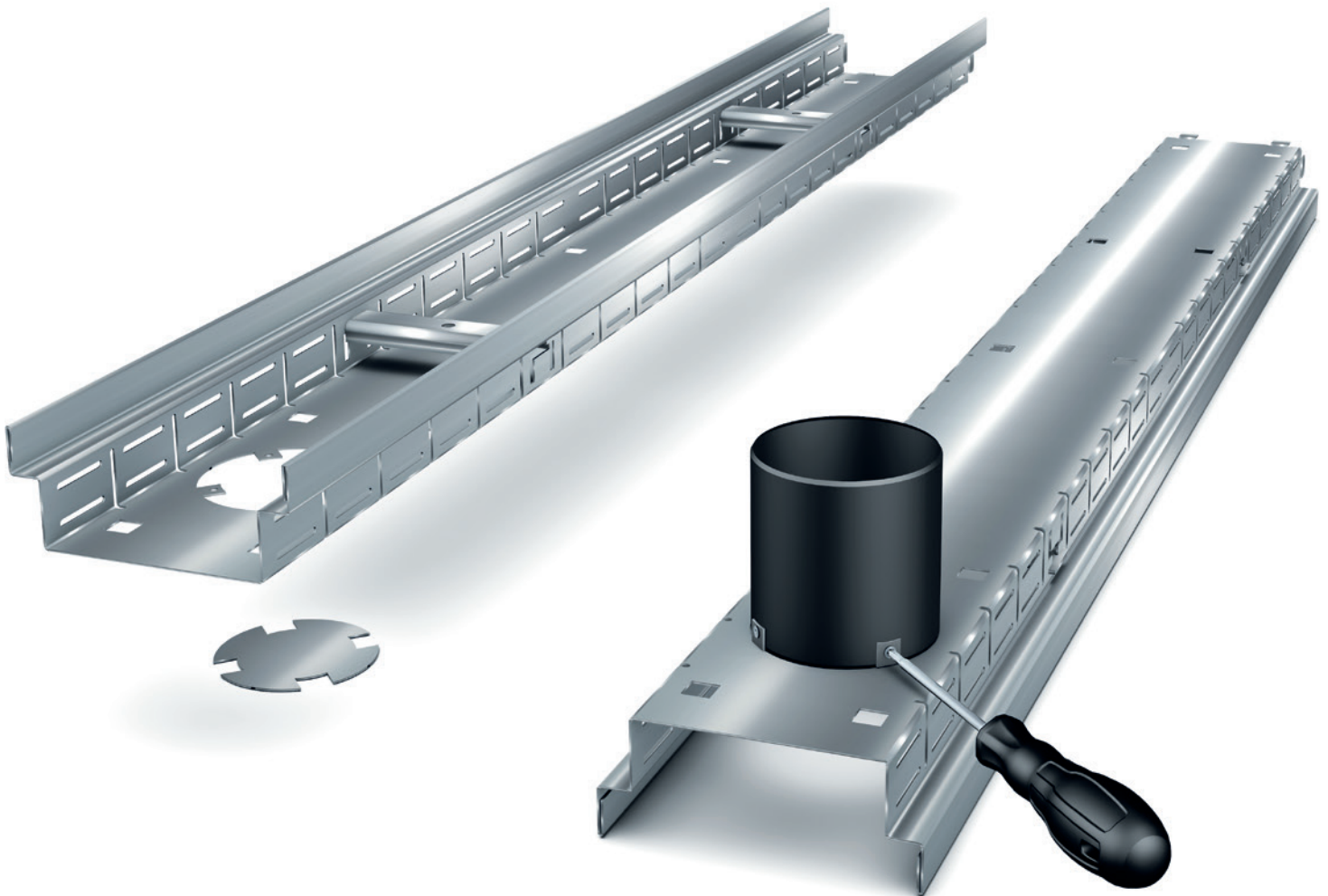



MEATEC II GRAVEL BAR

PROTECTION AGAINST GRAVEL PENETRATION

- > The integrated gravel border permits quick and easy installation
- > Depending of the height of the elevation just flip the gravel bar for height adjustment
- > Due to the symmetrical design the gravel bar can be mounted on both sides

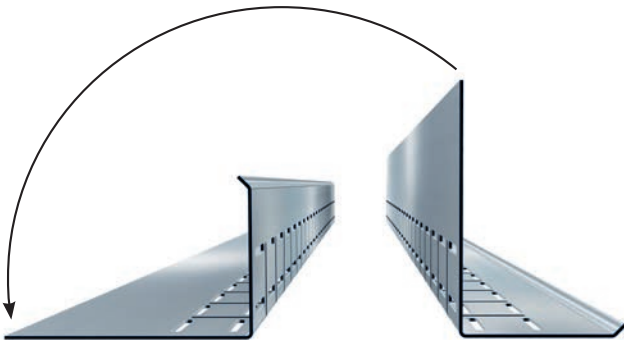
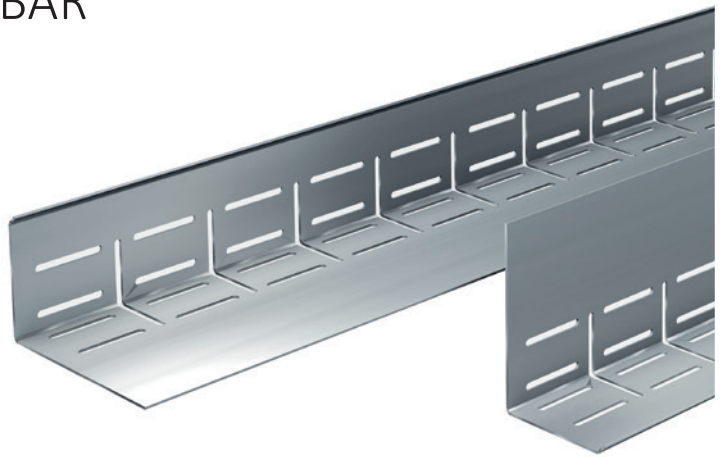

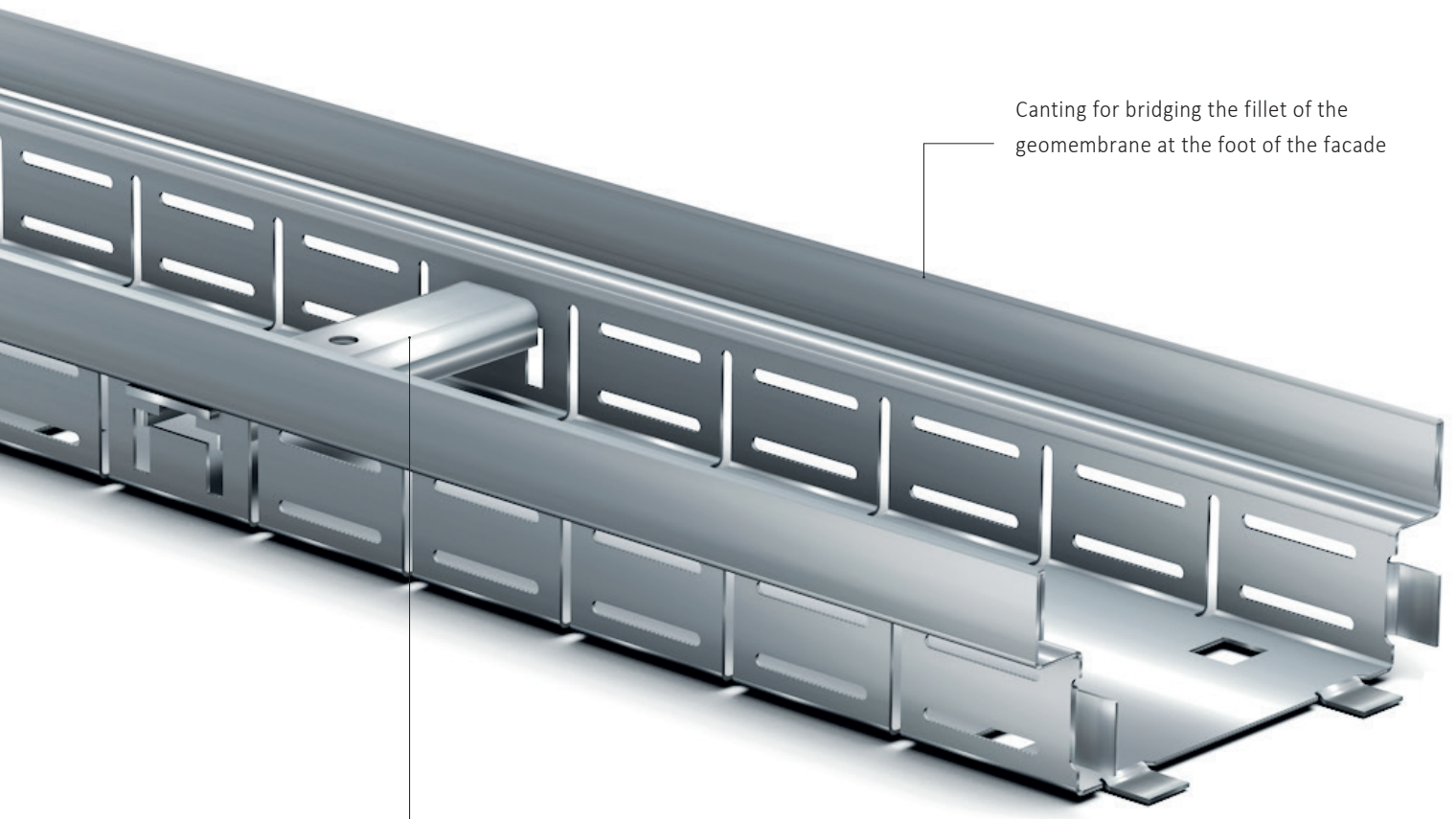

Canting for bridging the fillet of the geomembrane at the foot of the facade

Cross bracing:
two cross braces are normally
required for a 2 m channel section

MEATEC II LIGHTNESS COUPLED WITH EXTREME STABILITY

CROSS BRACING AS A STANDARD FEATURE ADDS STABILITY TO DRAINAGE CHANNELS

Drainage systems are subjected to heavy loads: they must therefore be built to last for several decades with virtually no maintenance.

- > Permanently installed cross bracing prevents loss of stability even when the grating covers are removed for cleaning
- > High lateral pressure due to gravel and paving has no effect on the original nominal width

MEATEC II CHANNEL COVERS – ELEGANT AND VERSATILE

DESIGN FOLLOWS FUNCTION

“Form follows function” is a well-known design principle – and the MEATEC system is no exception. All components were designed with optimal drainage in mind – at the point where facades meet terraces, roof gardens, balconies and many other kinds of surface. This basic idea runs through the entire MEATEC range:

- > The selection of gutter covers offers various variants to perfectly match the look to the surroundings.
- > Channel covers are available in galvanised steel, stainless steel and plastic

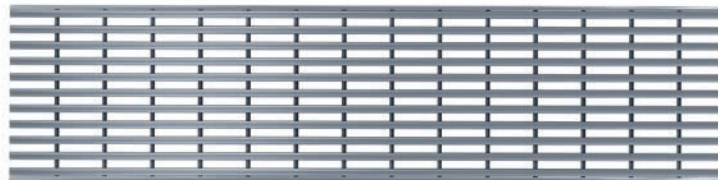

MEATEC PRIME longitudinal bar grating in stainless steel inclusive grate protection bolt for nominal width 130 and 160

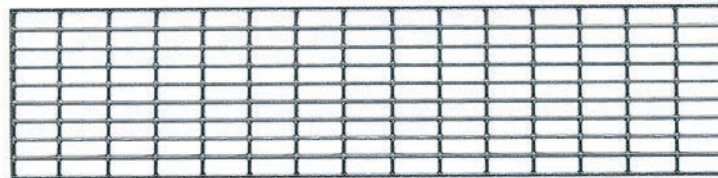

Mesh grating 30/10 in galvanised steel and stainless steel for all nominal widths

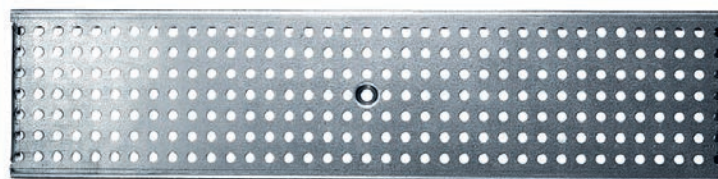

Dotted grating, in galvanised steel and stainless steel for nominal width 130



Plastic longitudinal bar grating for nominal width 130

MEATEC II INSTALLATION AND SYSTEM VARIANTS

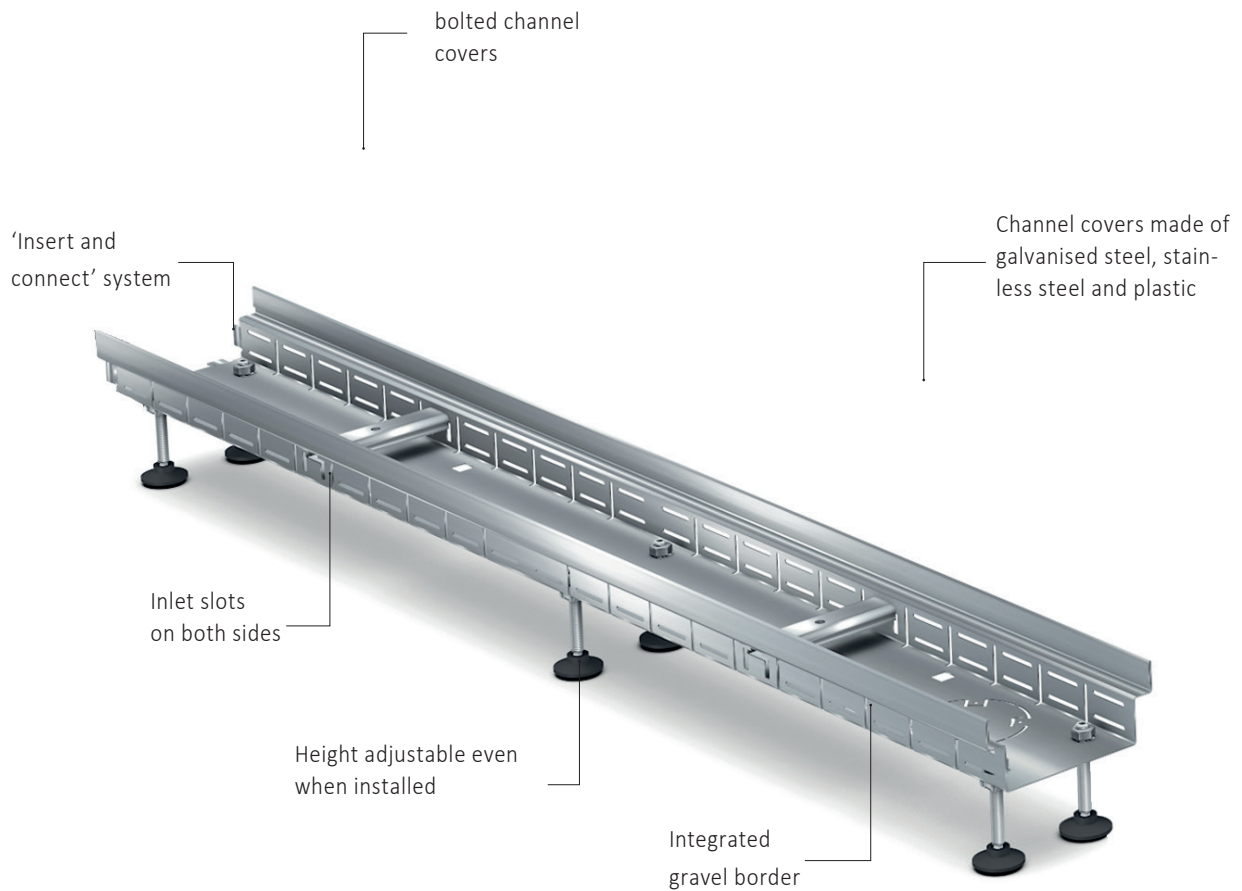

System versions at a glance MEATEC II:

Nominal widths: 100 / 130 / 160 / 200 / 250

Heights: 55 / 70 / 90 mm

Lengths: 1000 / 2000 mm

Accessories and gratings for

MEATEC 100 / 130 / 160 / 200 / 250

in galvanised steel and stainless steel:

- > End caps
- > Branch channel
- > Attachment
- > Elevation kit
- > Mesh grating 30/10

MEATEC 130 mm nominal width only:

- > Dotted grating in galvanised steel and stainless steel
- > Plastic longitudinal bar grating

MEATEC II INSTALLATION INSTRUCTIONS

INSTALLATION IN A PAVEMENT WITH GRAVEL BEDDING WITHOUT GUTTER, 15 CM STEP

MEATEC II - installation example 15 cm connection height above surface of covering, according to flat roof guideline, para. 4.4 (1), (warm roof)

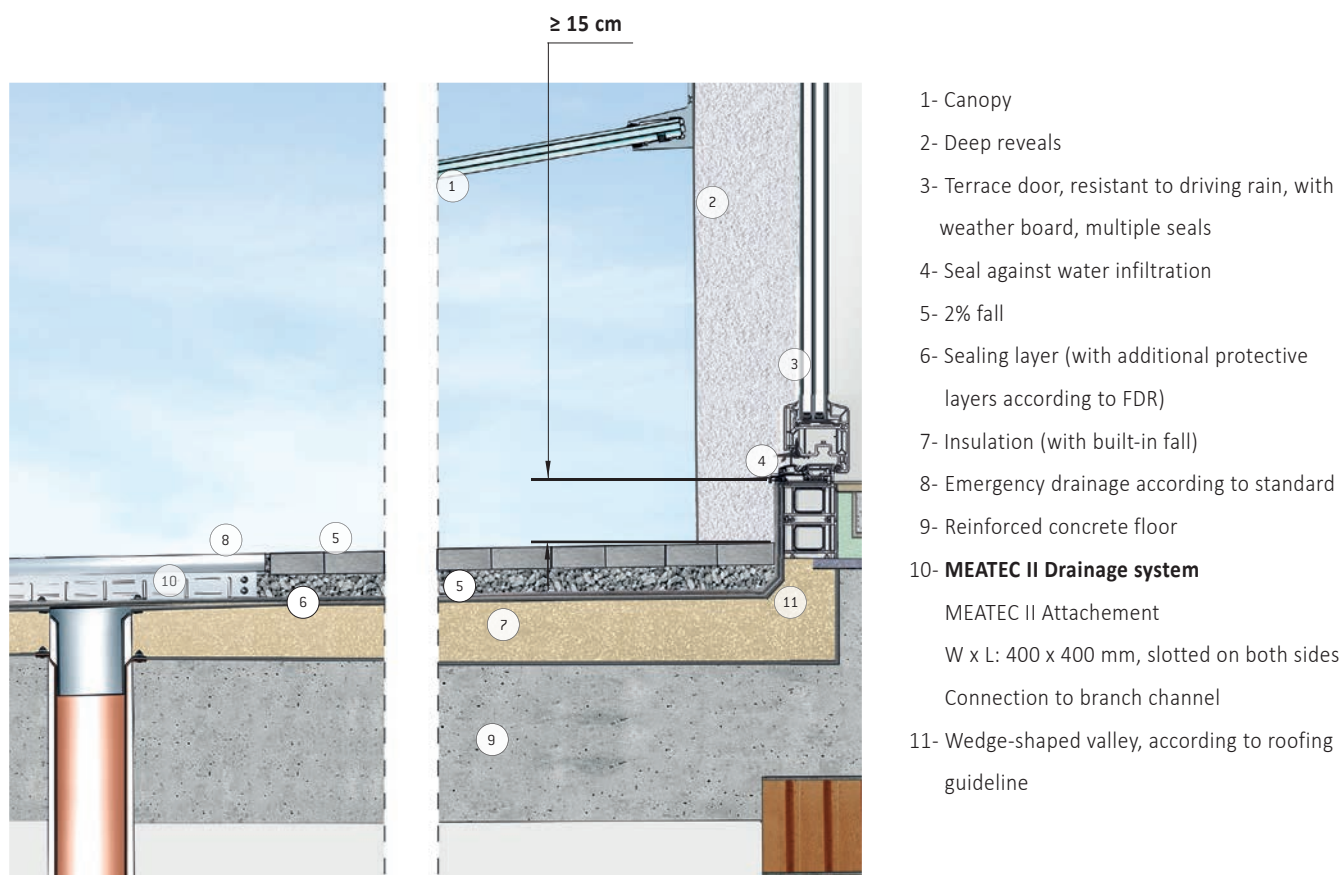

MEATEC II INSTALLATION INSTRUCTIONS

INSTALLATION IN A PAVEMENT WITH GRAVEL BEDDING IN COMBINATION WITH A PUNCTURE CHANNEL

MEATEC II installation example: connection height 5 cm above paving surface in accordance with flat roof regulations, Section 4.4 (2), Warm roof

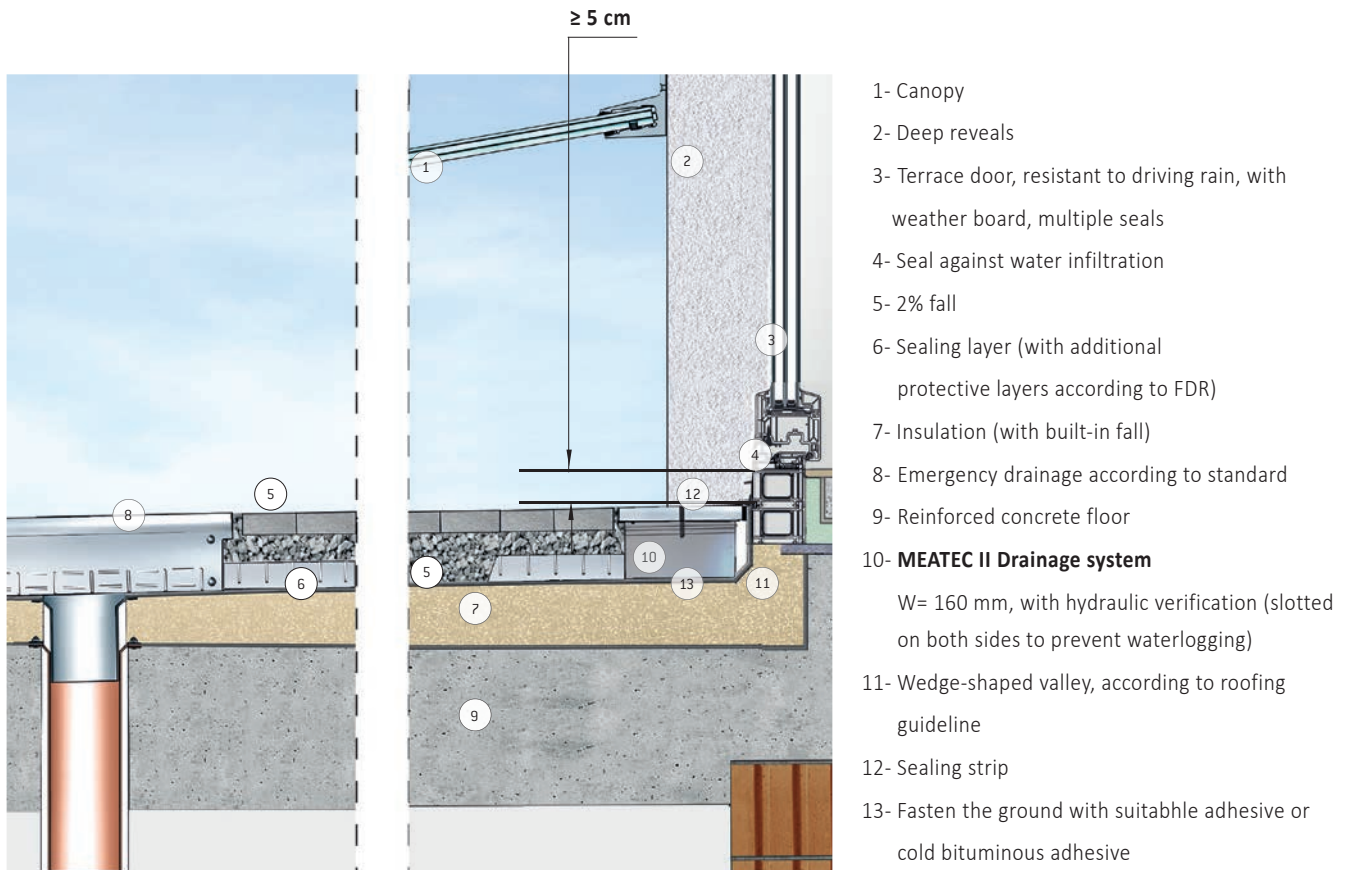

MEATEC II INSTALLATION INSTRUCTIONS

ELEVATED INSTALLATION IN A PAVED SURFACE WITH GRAVEL BEDDING IN COMBINATION WITH A DRAINAGE MAT

MEATEC II installation example for barrier-free construction according to DIN 18040 part 1 & 2 and flat roof guideline, para. 4.4 (3), (warm roof), ground must be checked with regard to load absorption

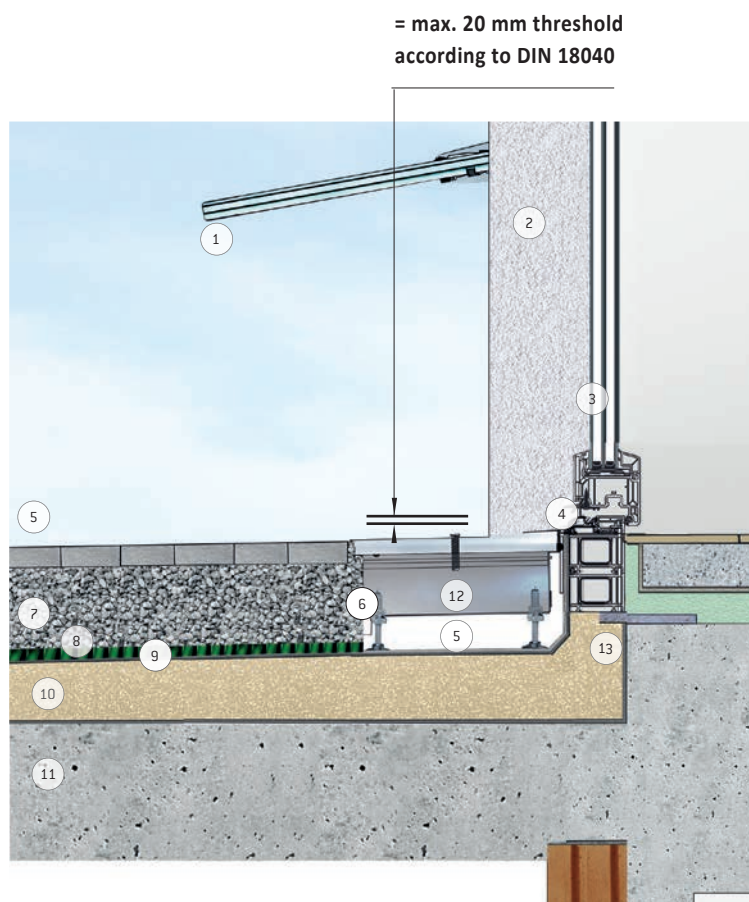

- 1- Canopy
- 2- Deep reveals
- 3- Terrace door, resistant to driving rain, with weather board, multiple seals
- 4- Seal against water infiltration
- 5- 2% fall
- 6- Gravel bar
- 7- Gravel
- 8- Fleece
- 9- Drainage mat
- 10- Insulation (with built-in fall)
- 11- Reinforced concrete floor
- 12- **MEATEC II Drainage system**
W= 250 mm, with hydraulic verification (slotted on both sides to prevent waterlogging)
- 13- Wedge-shaped valley, according to roofing guideline

MEATEC II INSTALLATION INSTRUCTIONS

ELEVATED INSTALLATION IN COMBINATION WITH ELEVATED SLAB DECKING

MEATEC II - Installation example for barrier-free construction according to DIN 18040 part 1 & 2 and flat roof guideline, para. 4.4 (3), warm roof

= max. 20 mm threshold
according to DIN 18040

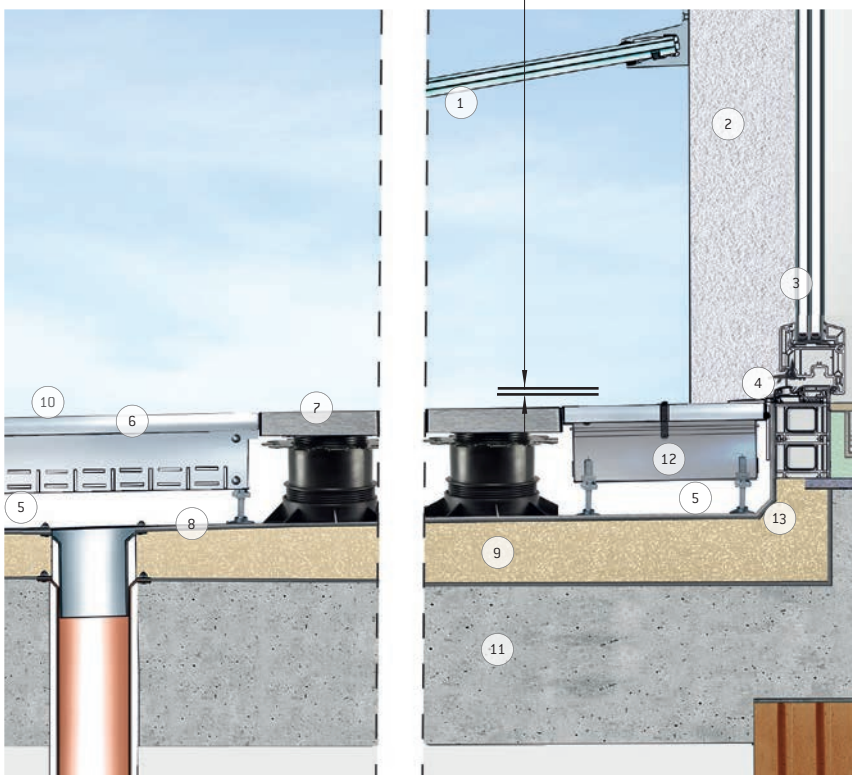

- 1- Canopy
- 2- Deep reveals
- 3- Terrace door, resistant to driving rain, with weather board, multiple seals
- 4- Seal against water infiltration
- 5- 2% fall
- 6- MEA attachment for roof drains
- 7- Raised pavement
- 8- Sealing layer (with additional protective layers according to FDR)
- 9- Insulation (with built-in fall)
- 10- Emergency drainage according to standard
- 11- Reinforced concrete floor
- 12- **MEATEC II 200 - 250**
MEATEC II drainage system, W= 200/250 mm with hydraulic verification (slotted on both sides to prevent waterlogging)
- 13- Wedge-shaped valley, according to roofing guideline

MEATEC II TECHNICAL DETAILS-

Example: MEATEC II 130

Channel body with fixed height

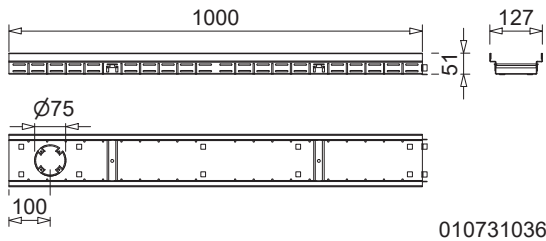

010731036

Accessories

End cap with height 50 mm

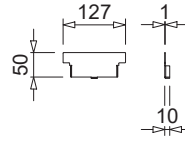

010731046

Channel covers

Mesh grating, loading class A 15, galvanised steel or stainless steel

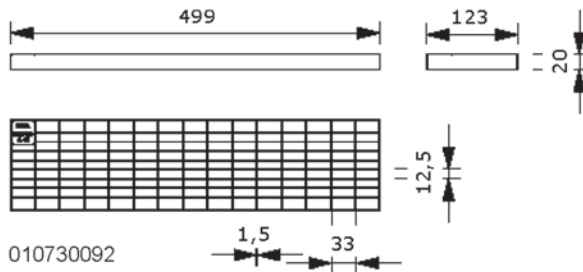

010730092

Dotted grating, loading class A 15, galvanised steel or stainless steel

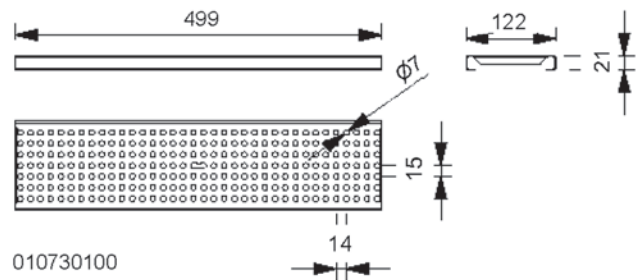

010730100

Plastic longitudinal bar grating, loading class A 15

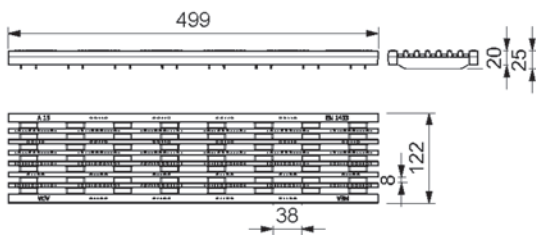

010730261

Branch channel

galvanised steel or stainless steel 90/24

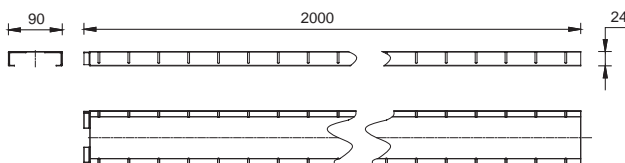

Attachment

400 x 400 mm, galvanised steel or stainless steel

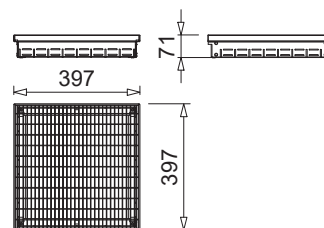

010731176



MEATEC II ECO-FRIENDLY AND DURABLE

ECO-FRIENDLY

The complete system is manufactured from high-quality galvanised or stainless steel.

- > Fully recyclable system
- > Temperature-resistant and therefore dimensionally stable
- > Non-wearing

MEATEC – a durable drainage solution and a sound long-term investment.





INNER COURTYARDS



PENTHOUSES AND GREEN ROOFS



BALCONIES AND TERRASSES

IMEATEC II APPLICATION AREAS



AESTHETIC



BARRIER-FREE CONSTRUCTION



ROOFTOPS

THE ADDITIONAL PRODUCT PORTFOLIO OF MEA WATER MANAGEMENT

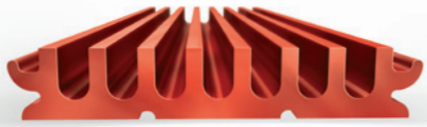

MEARIN PG EVO

Drainage solutions for underground car parks and multi-storey car parks



MEARIN

Professional lightweight drainage system made of GRP



MEADRAIN

Professional drainage systems for the heavy-duty sector



MEADRAIN TRAFFIC

Professional drainage systems for the streets and motorways



BUILDING SUCCESS

MEA Bautechnik GmbH ■ Sudetenstraße 1 ■ D-86551 Aichach ■ www.mea-group.com
Business unit MEA Water Management