

MATERIAL CHARACTERISTICS

FIBERGLASS COMPOSITE	glass-fibre-reinforced polyester, mineral fillers, additives
TENSILE STRENGTH	65 N/mm ² (ISO 527)
BENDING STRENGTH	120 N/mm ² (ISO 14125)
ELASTICITY MODULE	10.000 N/mm ² (ISO 14125)
DENSITY	2,0 g/cm ³ (ISO 1172)
COEFFICIENT OF LINEAR EXPANSION	1,5 – 2,0 x 10 ⁻⁵ 1/K
HEAT RESISTANCE	100°C continuous load, up to 240°C with a load duration up to 110 min.
FROST RESISTANCE	-35°C
WATER PENETRATION LEVEL	0 mm
WATER ABSORPTION	0,078 % (EN ISO 62:2008-05 Procedure 1)
MATERIAL STRUCTURE	Capillary free

PURPOSE OF USE

Component for the line drainage of surfaces in order to collect, transport and discharge rainwater from adjacent fixed surfaces.

***) Not suitable for the diagonal or transverse travel of motorways and highways.

MEARIN EXPERT 1000

A 15, B 125, C 250, D 400**, E 600**

CW 100

BUILDING SUCCESS

MEARIN EXPERT 1000 DRAINAGE CHANNEL WITHOUT FALL WITH INTEGRATED EDGE MADE OF GALVANISED STEEL (V) OR STAINLESS STEEL (E) AND SEALING JOINT ACCORDING TO EN 1433

Channels made of glass-fibre-reinforced composite. Clear width 100 mm, total width 132 mm. Suitable for all channel covers **MEA 100 CLIPFIX**, **MEA TSL 100** and **TSH 100 TOPSLOT**. For the realisation of water level slopes. Loading classes A 15 to E 600** according to EN 1433. Load capacity according to specification when installed according to the MEA installation instructions.

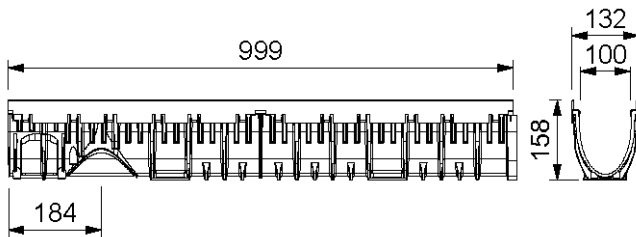

012140058

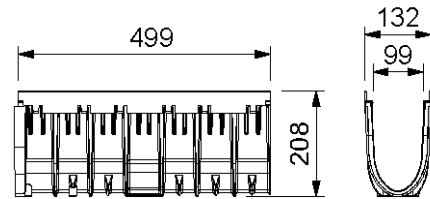

012140182

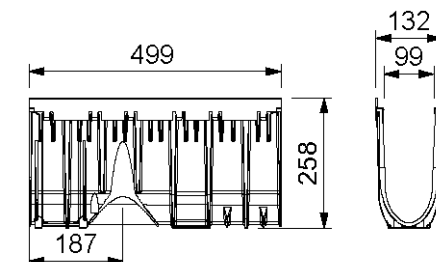

012140210

MEARIN EXPERT V 1000 DRAINAGE CHANNEL BODY WITHOUT FALL, LOADING CLASSES UP TO E 600 **)

Designation	Ord. No.	Length [mm]	Height [mm]	kg/unit
MEARIN EXPERT V 1000.0 Drainage channel body 4) 14) **)	012140058	1000	158	5,60
MEARIN EXPERT V 1000.1 Drainage channel body 3) **)	012140060	500	158	2,80
MEARIN EXPERT V 1000.1 RW Drainage channel body for change of drain direction 4) 14) 15) **)	012140062	500	158	2,80
MEARIN EXPERT V 1010.0 Drainage channel body 4) **)	012140180	1000	208	6,41
MEARIN EXPERT V 1010.1 Drainage channel body 3) **)	012140182	500	208	3,20
MEARIN EXPERT V 1010.1 RW Drainage channel body for change of drain direction 4) 15) **)	012140184	500	208	3,20
MEARIN EXPERT V 1020.0 Drainage channel body 4) **)	012140206	1000	258	7,24
MEARIN EXPERT V 1020.1 Drainage channel body 3) **)	012140208	500	258	3,62
MEARIN EXPERT V 1020.1 RW Drainage channel body for change of drain direction 4) 15) **)	012140210	500	258	3,62

- **)
- 3)
- 4)
- 14)
- 15)

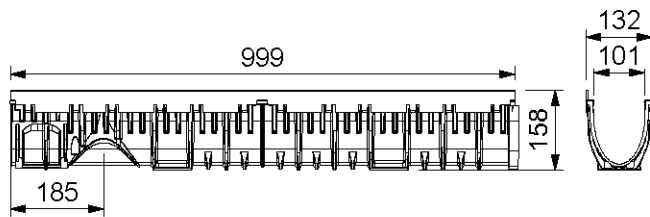

012140850

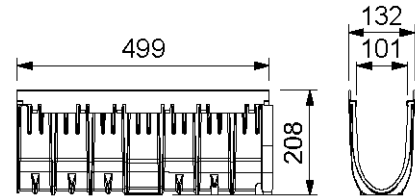

012140858

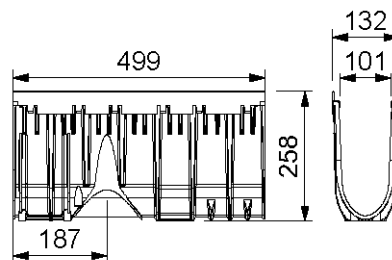

012140866

MEARIN EXPERT E 1000 DRAINAGE CHANNEL BODY WITHOUT FALL, LOADING CLASSES UP TO E 600 **)

Designation	Ord. No.	Length [mm]	Height [mm]	kg/unit
MEARIN EXPERT E 1000.0 Drainage channel body 4) **)	012140850	1000	158	5,60
MEARIN EXPERT E 1000.1 Drainage channel body 3) **)	012140852	500	158	2,80
MEARIN EXPERT E 1000.1 RW Drainage channel body for change of drain direction 4) **)	012140854	500	158	2,80
MEARIN EXPERT E 1010.0 Drainage channel body 4) **)	012140856	1000	208	6,41
MEARIN EXPERT E 1010.1 Drainage channel body 3) **)	012140858	500	208	3,20
MEARIN EXPERT E 1010.1 RW Drainage channel body for change of drain direction 4) **)	012140860	500	208	3,20
MEARIN EXPERT E 1020.0 Drainage channel body 4) **)	012140862	1000	258	7,24
MEARIN EXPERT E 1020.1 Drainage channel body 3) **)	012140864	500	258	3,62
MEARIN EXPERT E 1020.1 RW Drainage channel body for change of drain direction 4) **)	012140866	500	258	3,62

**) Not suitable for the diagonal or transverse travel of motorways and highways.

3) Connection option for end caps with connector or for gullies / silt boxes.

4) Connection option for vertical drain Ø 110 mm or to end caps with connector or to gullies / silt boxes.

MEARIN EXPERT 1000

A 15, B 125, C 250, D 400**, E 600**

CW 100

MEARIN EXPERT 1000 DRAINAGE CHANNEL WITH FALL (0.5%) WITH INTEGRATED EDGE MADE OF GALVANISED STEEL (V) OR STAINLESS STEEL (E) AND SEALING JOINT ACCORDING TO EN 1433

Channel body made of glass fiber reinforced composite. Clear width 100 mm, total width 132 mm. Suitable for all channel covers **MEA 100 CLIPFIX**, **TOPSLOTS TSL 100** and **TSH 100**. For the realisation of linear fall (with fall 0.5%). Loading classes A 15 to E 600** according to EN 1433. Load capacity according to specification when installed according to the MEA installation instructions.

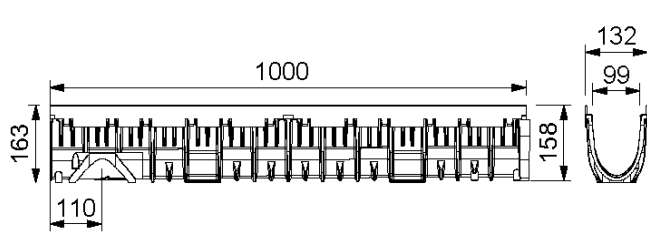

012140160

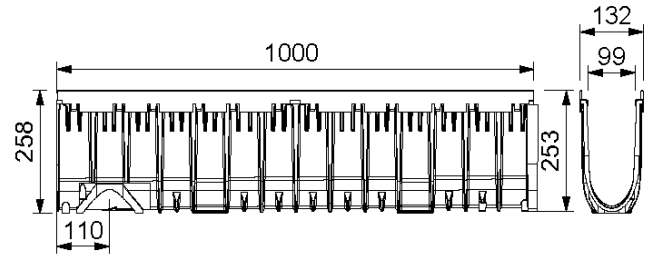

012140204

MEARIN EXPERT V 1000 DRAINAGE CHANNEL BODY WITH 0.5% FALL, LOADING CLASSES UP TO E 600 **)

Designation	Ord. No.	Length [mm]	Height [mm]	Height 2 [mm]	kg/unit
MEARIN EXPERT V 1001 Drainage channel body 1) **)	012140160	1000	158	163	5,77
MEARIN EXPERT V 1002 Drainage channel body 1) **)	012140162	1000	163	168	5,84
MEARIN EXPERT V 1003 Drainage channel body 1) **)	012140164	1000	168	173	5,92
MEARIN EXPERT V 1004 Drainage channel body 1) **)	012140166	1000	173	178	5,99
MEARIN EXPERT V 1005 Drainage channel body 1) **)	012140168	1000	178	183	6,07
MEARIN EXPERT V 1006 Drainage channel body 1) **)	012140170	1000	183	188	6,15
MEARIN EXPERT V 1007 Drainage channel body 1) **)	012140172	1000	188	193	6,22
MEARIN EXPERT V 1008 Drainage channel body 1) **)	012140174	1000	193	198	6,30
MEARIN EXPERT V 1009 Drainage channel body 1) **)	012140176	1000	198	203	6,37
MEARIN EXPERT V 1010 Drainage channel body 1) **)	012140178	1000	203	208	6,45
MEARIN EXPERT V 1011 Drainage channel body 1) **)	012140186	1000	208	213	6,53
MEARIN EXPERT V 1012 Drainage channel body 1) **)	012140188	1000	213	218	6,60
MEARIN EXPERT V 1013 Drainage channel body 1) **)	012140190	1000	218	223	6,68
MEARIN EXPERT V 1014 Drainage channel body 1) **)	012140192	1000	223	228	6,75
MEARIN EXPERT V 1015 Drainage channel body 1) **)	012140194	1000	228	233	6,83
MEARIN EXPERT V 1016 Drainage channel body 1) **)	012140196	1000	233	238	6,91
MEARIN EXPERT V 1017 Drainage channel body 1) **)	012140198	1000	238	243	6,98
MEARIN EXPERT V 1018 Drainage channel body 1) **)	012140200	1000	243	248	7,06
MEARIN EXPERT V 1019 Drainage channel body 1) **)	012140202	1000	248	253	7,13
MEARIN EXPERT V 1020 Drainage channel body 1) **)	012140204	1000	253	258	7,21

**) Not suitable for the diagonal or transverse travel of motorways and highways.

1) Connection option for vertical drain Ø 110 mm

MEARIN EXPERT 1000

A 15, B 125, C 250, D 400**, E 600**

CW 100



BUILDING SUCCESS

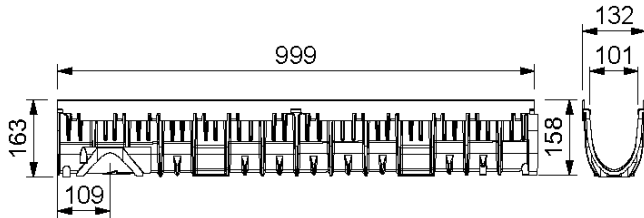

012140868

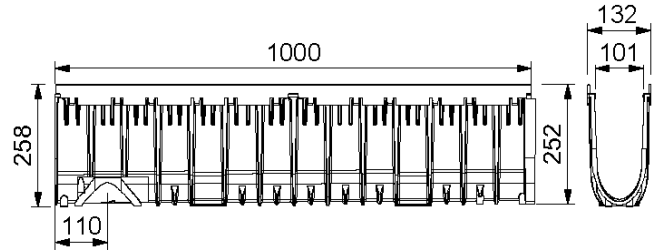

012140906

MEARIN EXPERT E 1000 DRAINAGE CHANNEL BODY WITH 0.5% FALL, LOADING CLASSES UP TO E 600 **)

Designation	Ord. No.	Length [mm]	Height [mm]	Height 2 [mm]	kg/unit
MEARIN EXPERT E 1001 Drainage channel body 1) **)	012140868	1000	158	163	5,77
MEARIN EXPERT E 1002 Drainage channel body 1) **)	012140870	1000	163	168	5,84
MEARIN EXPERT E 1003 Drainage channel body 1) **)	012140872	1000	168	173	5,92
MEARIN EXPERT E 1004 Drainage channel body 1) **)	012140874	1000	173	178	5,99
MEARIN EXPERT E 1005 Drainage channel body 1) **)	012140876	1000	178	183	6,07
MEARIN EXPERT E 1006 Drainage channel body 1) **)	012140878	1000	183	188	6,15
MEARIN EXPERT E 1007 Drainage channel body 1) **)	012140880	1000	188	193	6,22
MEARIN EXPERT E 1008 Drainage channel body 1) **)	012140882	1000	193	198	6,30
MEARIN EXPERT E 1009 Drainage channel body 1) **)	012140884	1000	198	203	6,37
MEARIN EXPERT E 1010 Drainage channel body 1) **)	012140886	1000	203	208	6,45
MEARIN EXPERT E 1011 Drainage channel body 1) **)	012140888	1000	208	213	6,53
MEARIN EXPERT E 1012 Drainage channel body 1) **)	012140890	1000	213	218	6,60
MEARIN EXPERT E 1013 Drainage channel body 1) **)	012140892	1000	218	223	6,68
MEARIN EXPERT E 1014 Drainage channel body 1) **)	012140894	1000	223	228	6,75
MEARIN EXPERT E 1015 Drainage channel body 1) **)	012140896	1000	228	233	6,83
MEARIN EXPERT E 1016 Drainage channel body 1) **)	012140898	1000	233	238	6,91
MEARIN EXPERT E 1017 Drainage channel body 1) **)	012140900	1000	238	243	6,98
MEARIN EXPERT E 1018 Drainage channel body 1) **)	012140902	1000	243	248	7,06
MEARIN EXPERT E 1019 Drainage channel body 1) **)	012140904	1000	248	253	7,13
MEARIN EXPERT E 1020 Drainage channel body 1) **)	012140906	1000	253	258	7,21

**) Not suitable for the diagonal or transverse travel of motorways and highways.

1) Connection option for vertical drain Ø 110 mm

MEARIN EXPERT 1000 ACCESSORIES

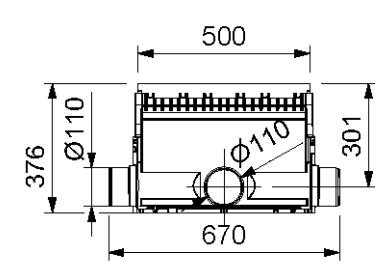

012140064

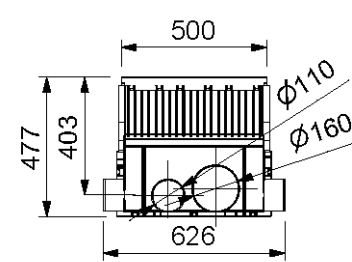
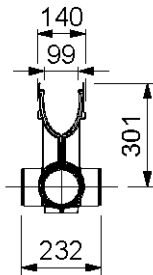

012140212

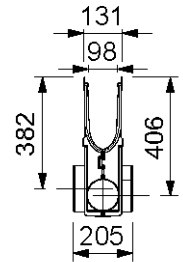

MEARIN EXPERT V 1000 GULLIES WITHOUT COVER, WITH SEDIMENT BUCKET **)

Designation	Ord. No.	Length [mm]	Height [mm]	kg/unit
MEARIN EXPERT V 1000.EK silt box with pipe connector Ø 110 mm + sediment bucket **)	012140064	500	376	5,40
MEARIN EXPERT V 1020.EK silt box with pipe connector Ø 110 mm/ Ø 160 mm + sediment bucket **)	012140212	500	478	6,82

MEARIN EXPERT E 1000 GULLIES WITHOUT COVER, WITH SEDIMENT BUCKET **)

Designation	Ord. No.	Length [mm]	Height [mm]	kg/unit
MEARIN EXPERT E 1000.EK silt box with pipe connector Ø 110 mm + sediment bucket **)	012140908	500	376	5,40
MEARIN EXPERT E 1020.EK silt box with pipe connector Ø 110 mm/ Ø 160 mm + sediment bucket **)	012140910	500	478	6,82

**) Not suitable for the diagonal or transverse travel of motorways and highways.

MEARIN EXPERT 1000

A 15, B 125, C 250, D 400**, E 600**

CW 100

BUILDING SUCCESS

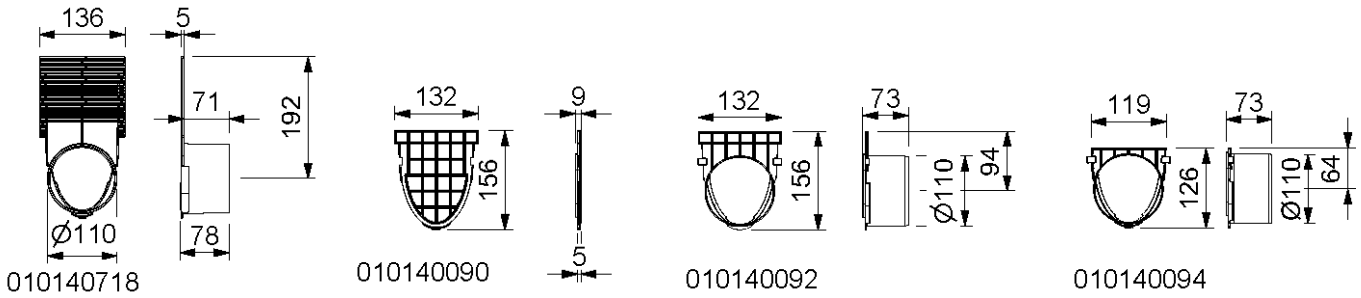

MEARIN EXPERT 1000 END CAPS

Designation	Ord. No.	Material	Height [mm]	kg/unit
MEARIN PLUS/EXPERT 1000-1020.SE/Ø110 End cap closed for channel start/end with optional pipe connection Ø 110 mm, height-adjustable	010140718	PC	155-255	0,06
MEARIN PLUS/EXPERT 1000.SE End cap closed for channel start/end	010140090	PP	156	0,04
MEARIN PLUS/EXPERT 1000.E End cap with pipe outlet Ø 110 mm for channel end	010140092	PP	156	0,06
MEARIN PLUS/EXPERT 1000.ES End cap with pipe outlet Ø 110 mm for a lateral channel connection	010140094	PP	126	0,08

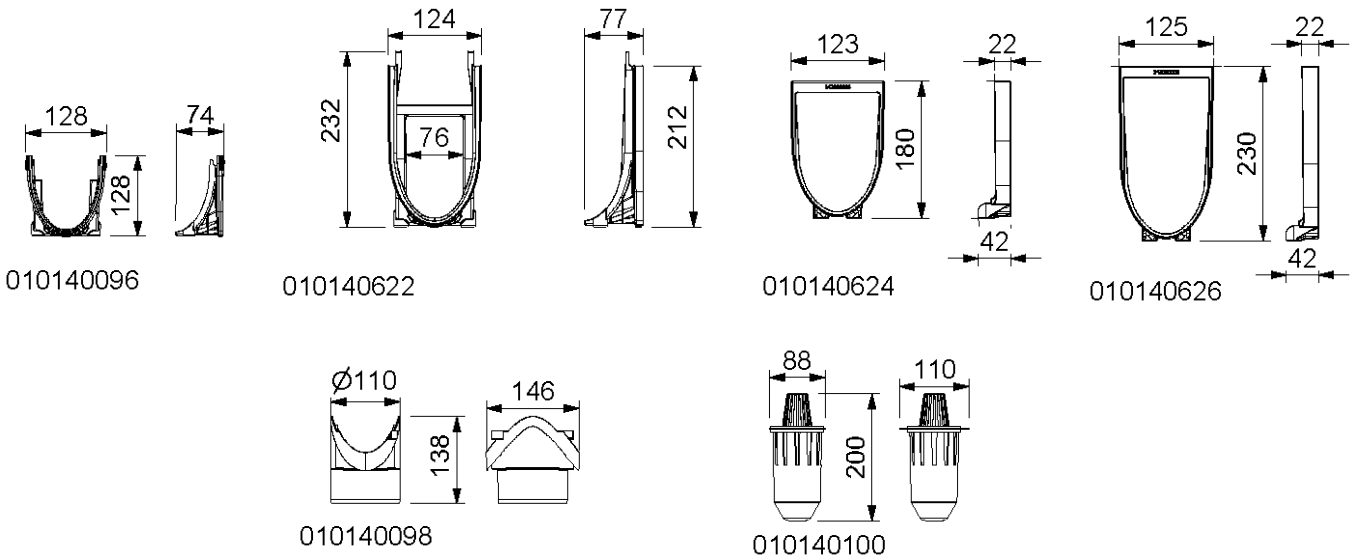

MEARIN EXPERT 1000 CONNECTION ACCESSORIES

Designation	Ord. No.	Material	kg/unit
MEARIN PLUS/EXPERT 1000.0 Adapter for lateral channel connection, for corner, T and cross connections	010140096	PP	0,04
MEARIN PLUS/EXPERT 1010.0 Adapter for lateral channel connection, for corner, T and cross connection	010140620	PC	0,07
MEARIN PLUS/EXPERT 1020.0 Adapter for lateral channel connection, for corner, T and cross connection	010140622	PC	0,08
MEARIN PLUS/EXPERT 1010.T Channel connector for strand low point, channels No. 10	010140624	PC	0,04
MEARIN PLUS/EXPERT 1020.T Channel connector for strand low point, channels No. 20	010140626	PC	0,05
MEARIN PLUS/EXPERT 1000 Vertical outlet connection Ø 110 mm	010140098	PP	0,08
MEARIN PLUS/EXPERT 1000 Odour trap, contains dirt filter and dirt trap	010140100	PP	0,20
MEARIN PLUS/EXPERT 1000 Drainage kit, contains vertical outlet connector Ø 110 mm, odour trap and 2 end caps closed	010140104	PP	0,35

**) Not suitable for the diagonal or transverse travel of motorways and highways.

JOINTING COMPOUNDS FOR STANDARD APPLICATIONS *)**

Designation	Ord. No.	Material	kg/unit
SABA MS Floor GREY sealant 600 ml in a bag, stable ***)	010152708	MS-polymer-basis	0,88
SABA Primer 9102 for undercoat, 1 liter	010155803	Silane-basis	0,92
Joint Cleaner solvent 48, 1 liter, Cleaner for adhesive flanks	010155807	-	0,84
Dispensing gun for 600 ml bags	010152707	-	0,79

**) Not suitable for the diagonal or transverse travel of motorways and highways.

***) For watertight mounting of drainage channels (only for channels transporting rainwater). Not suitable for installation in LAU-facilities, gaz stations or similar constructions.

This edition of the technical data sheet shall be valid from February 2023 until a revised version is published and replaces any previous publications. The respectively current version is available for download at www.mea-group.com.

MEA Bautechnik GmbH
 Business Unit MEA Water Management
 Sudetenstraße 1
 86551 Aichach
 Tel.: +49 (0) 82 51. 91 0
 Fax: +49 (0) 82 51. 91 13 06
 E-Mail: info@mea-group.com
www.mea-group.com